

PROFILE SYSTEM S2

L-SYSTEM
COMPONENTS & SOLUTIONS

About us

L-SYSTEM has solid experience in selling mechanics and automation components to the Nordic and European markets, something we've done since 1974.



Let's talk!

L-SYSTEM AB (Head office)

Mörsaregatan 20
254 66 Helsingborg
SWEDEN
info@l-system.se
+46 (0)42 38 61 50

L-SYSTEM ApS

Roms Hule 8 (Østtårne)
7100 Vejle
DENMARK
info@l-system.dk
+45 32 26 80 81

#weare|system



INDEX

S2 Technical Data	4
Grid dimension/Tolerances	9
Profiles Grid 20 - T-slot 5	10
Profiles Grid 30 - T-slot 6	14
Profiles Grid 40 - T-slot 8	20
Profiles Grid 50 - T-slot 10	36
Special Profiles	38
Tube Profiles	45
Conduit Profiles	47
Miscellaneous Profiles	54
Profiles X Grid - T-slot 10	61



All profiles are renewable and environmentally friendly.

S2 Technical Data

Grid	Item no.	Moment of inertia		Section modulus		Mass G (kg/m)	Profile surface A (cm ²)	Page
		I _x (cm ⁴)	I _y (cm ⁴)	W _x (cm ³)	W _y (cm ³)			
5	LS-I5 2020	0,74	0,74	0,74	0,74	0,49	1,82	10
5	LS-I5 2020 SE	0,74	0,74	0,74	0,74	0,49	1,82	10
5	LS-I5 20203N	0,82	0,74	0,78	0,74	0,52	1,92	10
5	LS-I5 20202NE	0,82	0,82	0,79	0,79	0,54	2,01	10
5	LS-I5 20202NP	0,74	0,81	0,74	0,81	0,51	1,89	11
5	LS-I5 20201N	0,78	0,81	0,76	0,81	0,52	1,92	11
5	LS-I5 2040	5,12	1,40	2,56	1,40	0,89	3,29	11
5	LS-I5 20404N	5,20	1,48	2,60	1,44	0,91	3,37	11
5	LS-I5 2060	16,07	2,07	5,36	2,07	1,28	4,76	12
5	LS-I5 2080	2,72	36,08	2,72	9,02	1,66	6,15	12
5	LS-I5 4040	9,24	9,24	4,62	4,62	1,38	5,10	12
5	LS-I5 8,516	0,06	0,22	0,12	0,28	0,22	0,82	12
5	LS-I5 1020	0,12	0,53	0,22	0,53	0,35	1,29	13
5	LS-I5 1040	0,24	3,63	0,45	1,81	0,64	2,39	13
5	LS-I5 20R90	0,58	0,58	0,54	0,54	0,46	1,72	13
6	LS-I6 3030	4,13	4,13	2,75	2,75	1,24	4,59	14
6	LS-I6 3030L	2,88	2,88	1,92	1,92	0,90	3,34	14
6	LS-I6 3030L3N	3,02	2,88	1,98	1,92	0,92	3,41	14
6	LS-I6 3030L2NE	3,02	3,02	1,98	1,98	0,94	3,48	14
6	LS-I6 3030L2NP	2,89	3,17	1,92	2,11	0,94	3,48	15
6	LS-I6 3030L1N	3,03	3,10	1,98	2,06	0,95	3,51	15
6	LS-I6 3060L	20,80	5,47	6,93	3,65	1,60	5,94	15
6	LS-I6 3060L4N	5,77	21,47	3,78	7,16	1,68	6,24	15
6	LS-I6 3060	28,90	7,85	9,63	5,24	2,24	8,31	16
6	LS-I6 6060L	38,69	38,69	12,90	12,90	2,62	9,71	16
6	LS-I6 6060	53,13	53,13	17,71	17,71	3,54	13,10	16
6	LS-I6 30120L	149,85	10,81	24,97	7,21	3,06	11,34	16
6	LS-I6 30120	207,28	15,31	34,55	10,20	4,25	15,73	17
6	LS-I6 60120L	252,25	74,95	42,04	24,98	4,88	18,07	17
6	LS-I6 60120	341,99	101,82	57,00	33,94	6,61	24,47	17
6	LS-I6 30LR90	2,14	2,14	1,30	1,30	0,81	2,99	17
6	LS-I6 3030L45°	2,20	2,20	1,32	1,32	0,82	3,05	18
6	LS-I6 1230L	0,26	1,47	0,41	0,98	0,43	1,58	18
6	LS-I6 1260L	0,55	10,04	0,85	3,35	0,81	3,01	18
8	LS-I8 3030	3,08	3,08	2,05	2,05	0,86	3,19	19
8	LS-I8 3060	20,82	6,38	6,92	4,24	1,78	6,61	19
8	LS-I8 4040E	8,12	8,12	4,06	4,06	1,48	5,47	20
8	LS-I8 4040E2NP	8,15	8,77	4,07	4,38	1,35	4,98	20
8	LS-I8 4040L	9,18	9,18	4,59	4,59	1,75	6,48	20
8	LS-I8 4040L SE	9,18	9,18	4,59	4,59	1,75	6,48	20
8	LS-I8 4040	14,14	14,14	7,07	7,07	2,47	9,14	21
8	LS-I8 4040L3N	9,80	9,19	4,78	4,60	1,80	6,65	21
8	LS-I8 4040L2NE	9,81	9,81	4,79	4,79	1,84	6,83	21
8	LS-I8 4040L2NP	10,45	9,20	5,22	4,60	1,84	6,83	21
8	LS-I8 4040L1N	9,82	10,46	4,80	5,23	1,89	7,00	22
8	LS-I8 4080E	60,20	15,93	15,05	7,96	2,48	9,18	22

S2 Technical Data

Grid	Item no.	Moment of inertia I _x (cm ⁴) I _y (cm ⁴)		Section modulus W _x (cm ³) W _y (cm ³)		Mass G (kg/m)	Profile surface A (cm ²)	Page
8	LS-I8 4080E3NE	56,50	15,97	13,83	7,82	2,29	8,46	22
8	LS-I8 4080E2NP	56,96	15,69	14,24	7,85	2,23	8,26	22
8	LS-I8 4080E4NP	56,15	16,37	14,04	8,19	2,33	8,63	23
8	LS-I8 4080L	70,07	16,93	17,52	8,47	3,05	11,31	23
8	LS-I8 4080L SE	70,07	16,93	17,52	8,47	3,05	11,31	23
8	LS-I8 4080	101,41	27,21	25,35	13,61	4,52	16,74	23
8	LS-I8 4080L4N	71,49	18,16	17,87	8,83	3,15	11,66	24
8	LS-I8 4080L5N	72,46	16,94	17,87	8,47	3,10	11,47	24
8	LS-I8 4080L3NE	73,74	17,86	18,19	8,71	3,16	11,72	24
8	LS-I8 408080L	96,07	96,07	20,69	20,69	4,80	17,78	24
8	LS-I8 8080E	103,32	103,32	25,83	25,83	4,08	15,12	25
8	LS-I8 8080L	134,90	134,90	33,72	33,72	5,33	19,75	25
8	LS-I8 8080L SE	134,90	134,90	33,72	33,72	5,33	19,75	25
8	LS-I8 8080	188,05	188,05	47,01	47,01	7,17	26,57	25
8	LS-I8 8080L6N	136,32	140,13	34,08	34,45	5,43	20,10	26
8	LS-I8 8080L4NE	141,55	141,55	34,81	34,81	5,52	20,45	26
8	LS-I8 8080L45	109,10	109,10	24,16	24,16	5,08	18,86	26
8	LS-I8 8080L4NE45	114,20	114,20	25,66	25,66	5,19	19,21	26
8	LS-I8 80AP					0,55	2,03	27
8	LS-I8 40120L	221,43	24,69	36,91	12,34	4,36	16,14	27
8	LS-I8 40120L5N	225,97	25,95	37,66	12,62	4,45	16,48	27
8	LS-I8 40120	322,57	40,28	53,76	20,14	6,57	24,33	27
8	LS-I8 40160L	501,91	32,44	62,74	16,22	5,66	20,97	28
8	LS-I8 40160	738,38	53,34	92,30	26,67	8,62	31,93	28
8	LS-I8 40160L6N	515,93	34,89	64,49	16,93	5,85	21,67	28
8	LS-I8 40200	1409,02	66,39	140,90	33,19	10,66	39,50	28
8	LS-I8 80120L	422,46	202,75	68,44	50,69	8,12	30,08	29
8	LS-I8 80120	574,22	274,63	92,99	68,66	10,76	39,86	29
8	LS-I8 120120	796,87	796,87	132,81	132,81	12,34	45,74	29
8	LS-I8 80160L	902,0	265,74	112,76	66,44	10,05	37,24	29
8	LS-I8 80160	1226,29	362,27	153,29	90,75	13,46	49,85	30
8	LS-I8 80160L8N	914,77	275,28	114,35	67,71	10,23	37,87	30
8	LS-I8 160160	2347,67	2347,67	293,46	293,46	19,91	73,75	30
8	LS-I8 1640E	0,67	3,38	0,82	1,69	0,62	2,28	30
8	LS-I8 1640	1,09	6,95	1,27	3,47	1,16	4,28	31
8	LS-I8 1680E	1,59	29,24	1,90	7,31	1,31	4,86	31
8	LS-I8 1680	2,20	49,34	2,62	12,34	2,16	8,01	31
8	LS-I8 16160	3,76	304,40	4,19	38,05	3,70	13,69	31
8	LS-I8 28160	726,07	20,75	90,76	14,50	8,37	30,99	32
8	LS-I8 28200	1381,36	25,71	138,13	18,03	10,33	38,27	32
8	LS-I8 28240	50,25	23,47	21,30	195,60	12,29	45,70	32
8	LS-I8 4032L	5,00	7,03	3,10	3,52	1,32	4,90	32
8	LS-I8 8032L	9,44	53,14	5,90	13,29	2,33	8,63	33
8	LS-I8 20152	7,56	350,58	7,35	46,19	4,93	18,27	33
8	LS-I8 2055	2,02	10,79	1,93	3,91	1,48	5,49	33
8	LS-I8 3218	1,87	1,10	1,15	1,22	0,67	2,48	33

S2 Technical Data

Grid	Item no.	Moment of inertia		Section modulus		Mass G (kg/m)	Profile surface A (cm ²)	Page
		I _x (cm ⁴)	I _y (cm ⁴)	W _x (cm ³)	W _y (cm ³)			
8	LS-I8 4040E45°	5,95	5,95	2,60	2,60	1,23	4,54	34
8	LS-I8 4040L45°	6,63	6,63	2,94	2,94	1,50	5,57	34
8	LS-I8 404045°	9,51	9,51	4,12	4,12	1,98	7,34	34
8	LS-I8 40RR30	6,56	8,99	2,91	3,83	1,68	6,22	34
8	LS-I8 40RR45	22,42	16,68	7,08	6,38	2,77	10,25	35
8	LS-I8 40RR60	35,44	22,89	9,33	7,59	2,86	10,60	35
8	LS-I8 40LR90	6,63	6,63	3,01	3,01	1,52	5,64	35
8	LS-I8 40RR90	75,94	75,94	18,78	18,78	3,94	14,60	35
10	LS-I10 5050E	20,38	20,38	8,15	8,15	2,29	8,49	36
10	LS-I10 5050	30,37	30,67	12,28	12,28	3,59	13,31	36
10	LS-I10 50100E	38,27	149,51	15,31	29,90	3,80	14,06	36
10	LS-I10 50100	62,16	228,44	24,86	45,69	6,69	24,78	36
10	LS-I10 100100E	249,92	249,92	49,98	49,98	6,17	22,86	37
10	LS-I10 100100	433,99	433,99	86,80	86,80	10,69	39,56	37
6	LS-I6 3030EKP	2,75	3,22	1,78	2,15	0,93	3,45	38
6	LS-I6 3030KP	3,17	3,51	2,02	2,31	1,09	4,04	38
6	LS-I6 3030KP180	3,49	3,81	2,33	2,49	1,21	4,49	38
6	LS-I6 KP	0,25	0,09	0,04	0,09	0,14	0,51	38
8	LS-I8 4040EKP	8,87	10,68	4,32	5,30	1,74	6,45	39
8	LS-I8 4040KP	10,14	11,52	4,86	5,71	2,01	7,46	39
8	LS-I8 4040KP 180	11,19	13,01	5,60	6,28	2,23	8,27	39
8	LS-I8 KP40	0,12	0,27	0,16	0,21	0,28	1,02	40
8	LS-I8 Rahmenprofil 4020	4,98	1,17	2,35	1,05	0,88	3,24	40
8	LS-I8 SF1040	0,22	3,56	0,44	1,79	0,74	2,72	41
8	LS-I8 LRP D10	12,54	18,80	6,41	6,52	2,48	9,21	41
8	LS-I8 LRP D14	47,90	47,90	10,74	15,33	4,18	15,48	41
8	LS-I8 4040LBP	7,95	10,61	3,41	5,31	1,42	5,27	41
	LS-W 40x25x2	0,64	2,10	0,33	0,78	0,34	1,25	42
	LS-W 40x20x4	0,59	3,52	0,38	1,40	0,59	2,21	42
	LS-W 40x40x4	4,51	4,51	1,58	1,58	0,81	3,01	42
	LS-W 80x80x8	72,27	72,27	12,66	12,66	3,25	12,05	42
	LS-P 40x4					0,42	1,57	43
8	LS-I8 CSP Rail Profile	84,59	16,83	14,33	7,09	2,92	10,83	43
8	LS-I8 CSP Carriage Pr.	42,48	16,25	7,73	6,75	2,65	9,81	43
8	LS-I 4080T	76,99	20,50	19,24	10,25	2,58	9,54	44
8	LS-I 4080TI	33,32	10,46	9,56	6,53	2,61	9,64	44
8	LS-I8 RB200	2,97	361,95	2,00	33,55	2,52	9,34	44
8	LS-I8 RB320	7,71	1400,80	4,62	82,85	4,02	14,90	44
	LS-I D30	1,30	1,30	0,86	0,86	0,34	1,27	45
	LS-I D30K	1,70	1,70	1,13	1,13	0,53	1,96	45
8	LS-I8 D30K1N	1,20	2,33	0,91	1,55	0,74	2,75	45
	LS-I D30H	3,05	3,05	2,03	2,03	1,20	4,45	45
	LS-I D32	1,47	1,47	0,92	0,92	0,34	1,25	46
	LS-I D50	8,11	8,12	3,24	3,25	0,76	2,81	46
	LS-I KK3030E					0,30	1,12	47
	LS-I KK30D					0,24	0,90	47

S2 Technical Data

Grid	Item no.	Moment of inertia		Section modulus		Mass G (kg/m)	Profile surface A (cm ²)	Page
		I _x (cm ⁴)	I _y (cm ⁴)	W _x (cm ³)	W _y (cm ³)			
	LS-I KK3060E					0,41	1,51	47
	LS-I KK6060					1,07	3,96	47
	LS-I KK6060E					0,91	3,38	48
	LS-I KK60D					0,39	1,45	48
	LS-I KK4020					0,26	0,96	48
	LS-I KK4040					0,58	2,16	48
	LS-I KK4040E					0,46	1,70	49
	LS-I KK8040					1,19	4,40	49
	LS-I KK8040E					1,08	3,98	49
	LS-I KK4080					0,91	3,38	49
	LS-I KK4080E					0,81	3,01	50
	LS-I KK8080					1,53	5,67	50
	LS-I KK8080E					1,40	5,18	50
	LS-I KK40D					0,31	1,13	50
	LS-I KK80D					0,55	2,04	51
	LS-I TP 80					0,72	2,68	51
8	LS-I8 TP 80					1,08	3,99	51
	LS-I WP 40					0,19	0,73	52
	LS-I WP 80					0,54	2,03	52
8	LS-I TP 120					0,99	3,67	52
8	LS-I8 TP 120					1,62	5,99	52
	LS-I WP 120					0,81	3,02	53
	LS-I TP 160					1,27	4,67	53
8	LS-I8 4080SP2K	63,31	7,57	15,83	3,60	2,08	7,71	54
8	LS-I8 Abdeckprofil AL60					0,36	1,35	54
8	LS-I8 Verbindungsprofil 40	19,82	5,70	6,95	2,88	2,40	8,90	55
8	LS-I8 Abdeckprofil 32 AL					0,11	0,39	55
5	LS-I5 Wellenklemmprofil 6					0,08	0,29	56
8	LS-I8 Wellenklemmprofil 10					0,21	0,80	56
8	LS-I8 Wellenklemmprofil 14					0,34	1,26	56
5	LS-I5 Griffleiste					0,77	2,84	56
8	LS-I8 Schanierprofil e					0,68	2,52	57
8	LS-I8 Schanierprofil z					0,66	2,46	57
8	LS-I8 Scheibeneinfassleiste					0,25	0,91	57
8	LS-I8 W SL E	0,35	0,43	0,31	0,42	0,36	1,32	58
8	LS-I8 WL	0,79	0,24	0,44	0,23	0,32	1,20	58
8/5	LS-I8 RP01	5,80	10,38	2,30	5,19	1,34	4,97	59
6	LS-I6 Abdeckprofil AI					0,03	0,09	59
8	LS-I8 WL M6					0,32	1,20	59
8	LS-I8 WL M6 KM					0,32	1,20	59
8	LS-I8 WL K M5					0,26	0,96	60
8	LS-I8 NP M8 40					0,29	1,07	60
8	LS-I8 NP M8 60					0,29	1,07	60
8	LS-I8 NP	0,06	0,14	0,12	0,18	0,29	1,07	60
8	LS-I8 X4040TP	8,74	9,58	4,31	4,45	1,88	6,98	61

S2 Technical Data

Grid	Item no.	Moment of inertia		Section modulus		Mass G (kg/m)	Profile surface	
		I _x (cm ⁴)	I _y (cm ⁴)	W _x (cm ³)	W _y (cm ³)		A (cm ²)	
8	LS-I8 X4080L4N	73,67	19,96	18,42	9,72	3,30	12,23	61
8	LS-I8X4080L4N K	71,11	17,77	17,78	8,28	2,94	10,90	61
8	LS-I8 X4080L5N	75,10	18,39	18,54	9,19	3,47	12,85	61
8	LS-I8 X40120L	226,02	24,94	37,67	12,47	4,37	16,19	62
8	LS-I8 X8080L4NE	140,08	140,08	34,82	34,82	5,50	20,37	62
8	LS-I8 X8080L2NPK	115,58	129,64	28,21	32,41	4,94	18,28	62

Profile-slot loading capacity

Grid	Item no.	Hammer-head screw	Hammer-head nut	Roll-In-T-slot nut	T-Slot nut
5	LS-I5 2020, LS-I5 2040 LS-I5 2080, LS-I5 4040 LS-I5 1020, LS-I5 1040 LS-I5 20R90			1000 N	
6	LS-I6 3030, LS-I6 3060 LS-I6 6060, LS-I6 30120 LS-I6 60120			3500 N	
6	LS-I6 3030L, LS-I6 3060L LS-I6 6060L, LS-I6 30120L LS-I6 60120L, LS-I6 30LR90 LS-I6 3030L45			1000 N	
8	LS-I8 4040L, LS-I8 4080L LS-I8 408080L, LS-I8 8080L LS-I8 40120L, LS-I8 40160L LS-I8 80120L, LS-I8 80160L LS-I8 4032L, LS-I8 8032L LS-I8 4040L45	10000 N	10000 N		15000 N
8	LS-I8 4040, LS-I8 4080 LS-I8 8080, LS-I8 40120 LS-I8 40160, LS-I8 40200 LS-I8 80120, LS-I8 80160 LS-I8 120120, LS-I8 160160 LS-I8 1640, LS-I8 1680 LS-I8 16160, LS-I8 28160 LS-I8 28200, LS-I8 28240 LS-I8 20152, LS-I8 2055 LS-I8 404045	10000 N	10000 N		15000 N
8	LS-I8 4040E, LS-I8 4080E LS-I8 8080E, LS-I8 1640E LS-I8 4040E45	5000 N	5000 N		7000 N
10	LS-I10 5050, LS-10 5050E	4000 N	4000 N		6000 N

Profile Material

• EN AW – 6063 T6	: DIN EN 573
• R _m (Minimum tensile strength)	: 245 N/mm ²
• R _p 0,2 (Proof stress in direction of pressure)	: 195 N/mm ²
• A5 (Ductile yield)	: 10%
• A10 (Ductile yield)	: 8%
• E (Modulus of elasticity)	: Approx. 70.000 N/mm ²
• Brinell hardness	: Approx. 75 HB
• α (Longitudinal expansion coefficient)	: 23,4 x 10 ⁻⁶ 1/K
• Anodizing/thickness	: E6 ECO/10-15µm

S2 Technical Data

Grid dimension R (mm) / Tolerances

Grid	20	30	40	50
------	----	----	----	----



	T-nut 5	T-nut 6	T-nut 8	T-nut 10
a	5,0 +0,3/-0	6,2 +0,3/-0	8,0 +0,4/-0	10 +0,4/0
b	11,5 +0,3/-0	16,3 +0,3/-0	20,0 +0,4/-0	25 +0,4/-0
c	6,35 ±0,15	9,75 +0,2/-0	12,25 +0,3/-0	1,5 +0,3/-0
d	1,8 ±0,1	3,0 +0/-0,25	4,5 +0,3/-0	5,3 +0,3/-0
e	0,15 ±0,1	0,15 ±0,1	0,2 ±0,1	0,25 ±0,1
d1	4,3 ±0,1	5,0 +0,2/-0	6,8 +0/-0,2	8,5 +0,1/-0,2

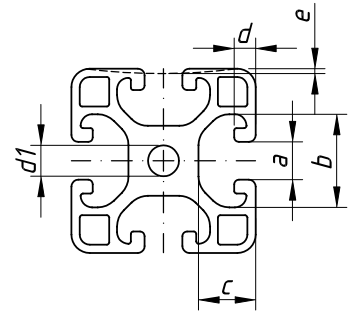

Edge length of profile

Tolerance

a (mm)		Position of nut (n) ±
at	to	
0	10	±0,1
10	20	±0,15
20	40	±0,2
40	60	±0,3
60	80	±0,4
80	100	±0,45
100	120	±0,50
120	160	±0,6
160	240	±0,8
240	320	±1,50

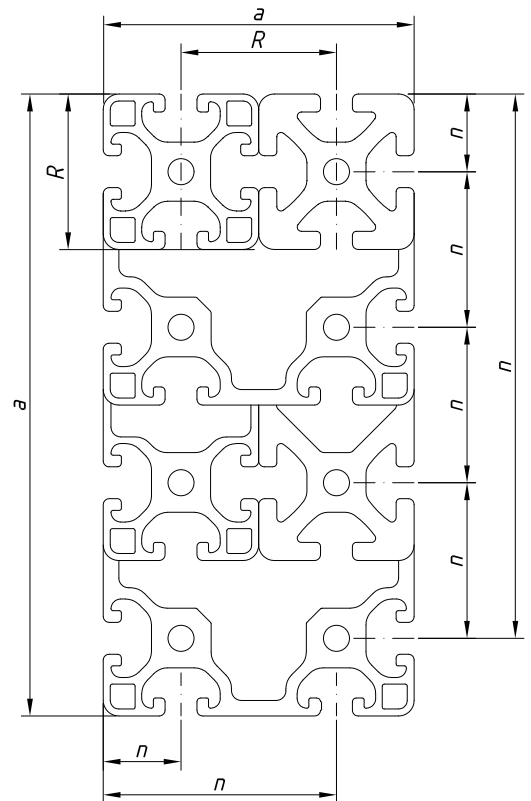

20

Profile Grid 20



Item no. LS-I5 2020 / LS-I5 2020 SL06

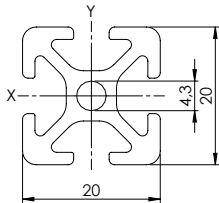

PU
LENGTH 16 Pcs.
LENGTH 3060 mm
LENGTH 6060 mm



Item no. LS-I5 2020 SE

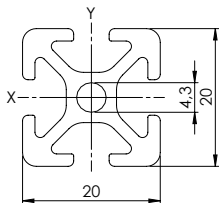

PU
LENGTH 16 Pcs.
LENGTH 3060 mm



Item no. LS-I5 20203N

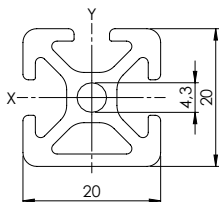

PU
LENGTH 16 Pcs.
LENGTH 3060 mm



Item no. LS-I5 20202NE

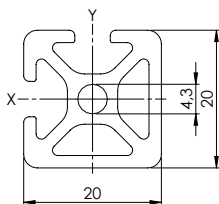

PU
LENGTH 16 Pcs.
LENGTH 3060 mm

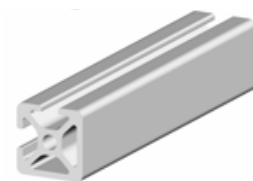

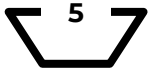

Profile Grid 20

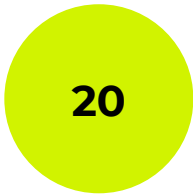

Item no. LS-I5 20202NP

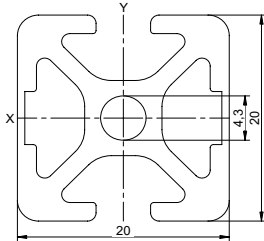

PU LENGTH

16 Pcs.
3060 mm

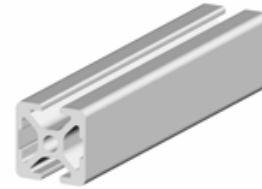

Item no. LS-I5 20201N

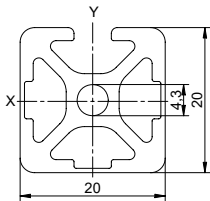

PU LENGTH

16 Pcs.
3060 mm

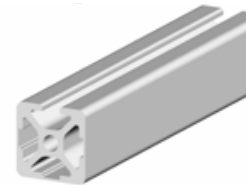

Item no. LS-I5 2040 / LS-I5 2040 SL06

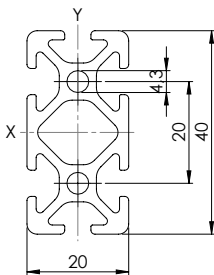

PU LENGTH
LENGTH

16 Pcs.
3060 mm
6060 mm

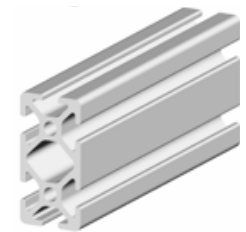

Item no. LS-I5 20404N

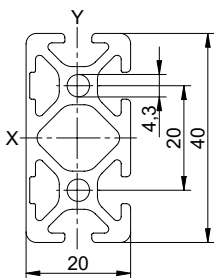

PU LENGTH

8 Pcs.
3060 mm





20

Profile Grid 20

Item no.	LS-I5 2060		
	PU LENGTH	5 Pcs. 3060 mm	
Item no.	LS-I5 2080		
	PU LENGTH	8 Pcs. 3060 mm	
Item no.	LS-I5 4040		
	PU LENGTH	8 Pcs. 6060 mm	
Item no.	LS-I5 8,516		
	PU LENGTH	10 Pcs. 3060 mm	



Profile Grid 20



Item no. LS-I5 1020

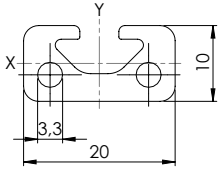

PU LENGTH

16 Pcs.
3060 mm



Item no. LS-I5 1040

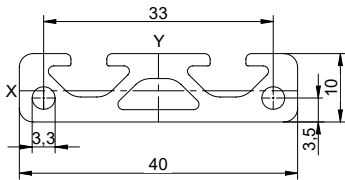

PU LENGTH

16 Pcs.
3060 mm

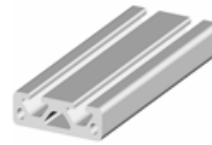

Item no. LS-I5 20R90

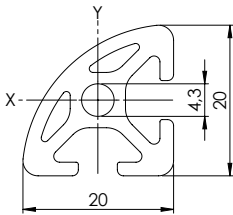

PU LENGTH

8 Pcs.
3060 mm





30

Profile Grid 30

Item no.	LS-I6 3030		
	PU LENGTH	16 Pcs. 6060 mm	
Item no.	LS-I6 3030L		
	PU LENGTH	16 Pcs. 6060 mm	
Item no.	LS-I6 3030L3N		
	PU LENGTH	8 Pcs. 6060 mm	
Item no.	LS-I6 3030L2NE		
	PU LENGTH	8 Pcs. 6060 mm	



Profile Grid 30

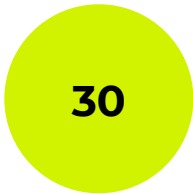

Item no. LS-I6 3030L2NP

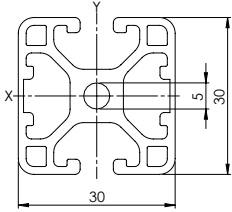

PU LENGTH

8 Pcs.
6060 mm

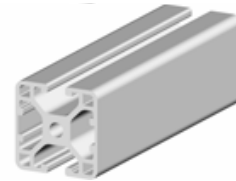

Item no. LS-I6 3030LIN

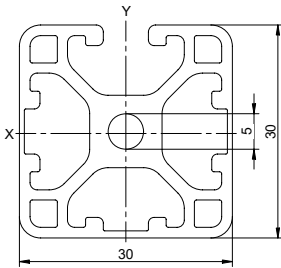

PU LENGTH

8 Pcs.
6060 mm

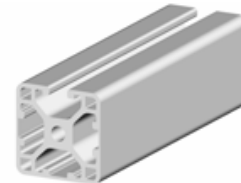

Item no. LS-I6 3060L

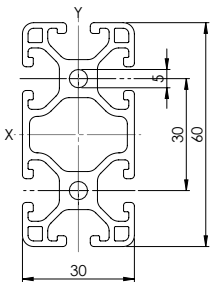

PU LENGTH

8 Pcs.
6060 mm

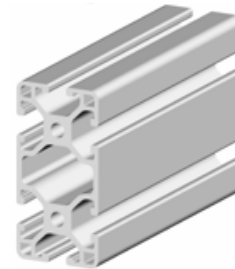

Item no. LS-I6 3060L4N

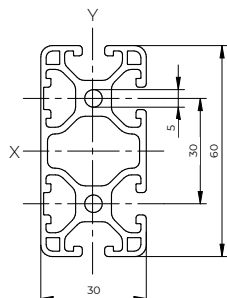

PU LENGTH

4 Pcs.
6060 mm

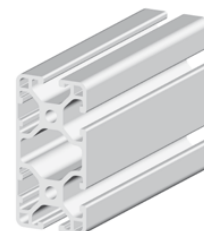



30

Profile Grid 30

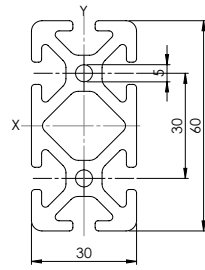
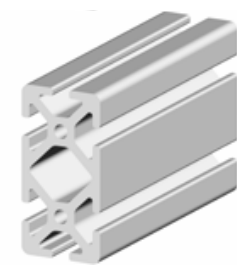
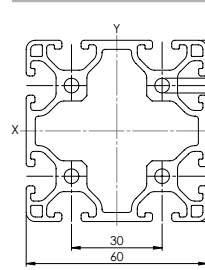
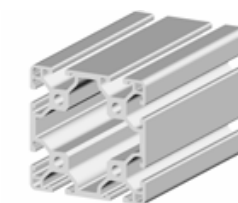
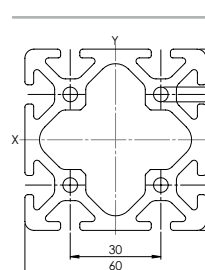
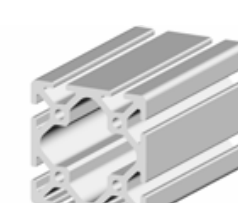
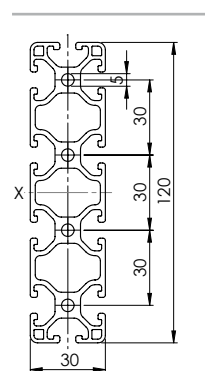
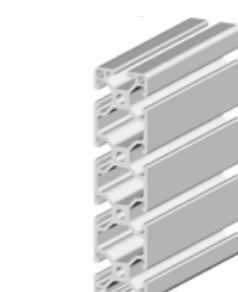
Item no.	LS-I6 3060		
	PU LENGTH	8 Pcs. 6060 mm	
Item no.	LS-I6 6060L		
	PU LENGTH	4 Pcs. 6060 mm	
Item no.	LS-I6 6060		
	PU LENGTH	4 Pcs. 6060 mm	
Item no.	LS-I6 30120L		
	PU LENGTH	4 Pcs. 6060 mm	

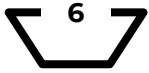

Profile Grid 30

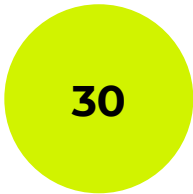

Item no. LS-I6 30120

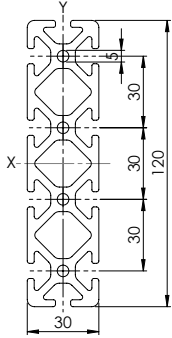

PU LENGTH

4 Pcs.
6060 mm



Item no. LS-I6 60120L

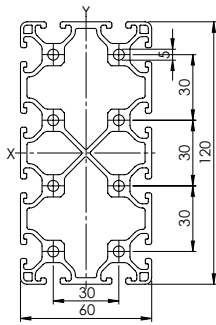

PU LENGTH

2 Pcs.
6060 mm

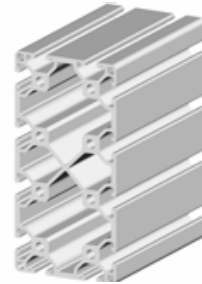

Item no. LS-I6 60120

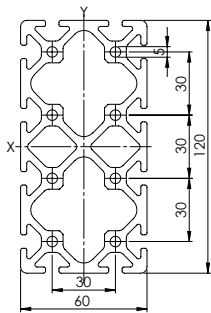

PU LENGTH

2 Pcs.
6060 mm

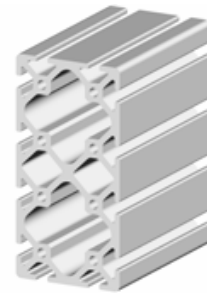

Item no. LS-I6 30LR90

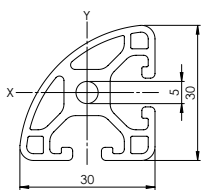

PU LENGTH

8 Pcs.
3060 mm

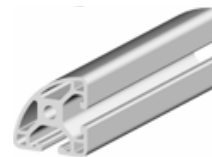



30

Profile Grid 30

Item no. LS-I6 3030L45°

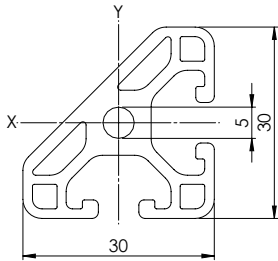

PU
LENGTH

8 Pcs.
3060 mm



Item no. LS-I6 1230L

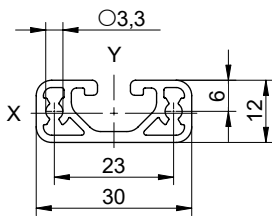

PU
LENGTH

10 Pcs.
3060 mm



Item no. LS-I6 1260L

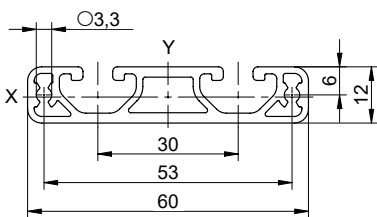

PU
LENGTH

10 Pcs.
3060 mm

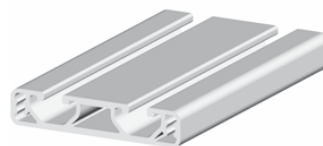



Profile Grid 30

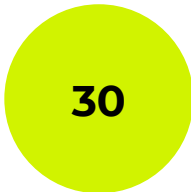

Item no. LS-I8 3030

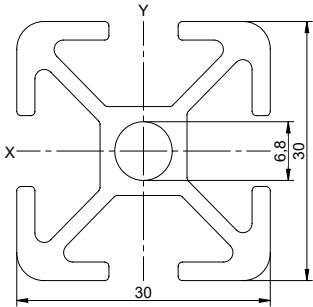

PU LENGTH

16 Pcs.
6060 mm

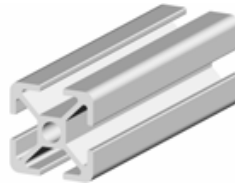

Item no. LS-I8 3060

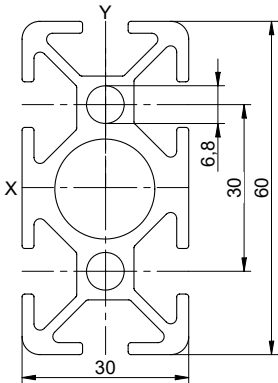

PU LENGTH

8 Pcs.
6060 mm

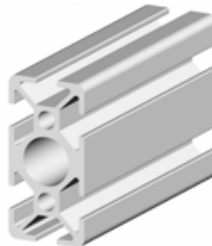



40

Profile Grid 40

Item no. LS-I8 4040E / LS-I8 4040E PAL

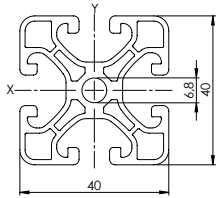

PU
PU / PAL
LENGTH

16 Pcs.
108 Pcs.
6060 mm

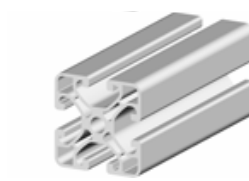

Item no. LS-I8 4040E2NP

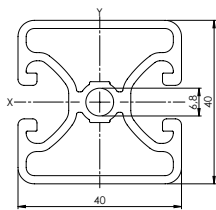

PU
LENGTH

16 Pcs.
6060 mm

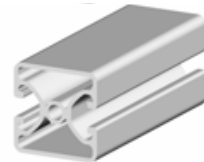

Item no. LS-I8 4040L / LS-I8 4040L PAL / LS-I8 4040L SL03

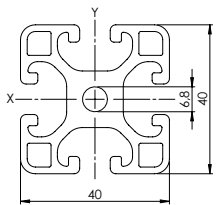

PU
PU / PAL
PU / SL03
LENGTH
LENGTH

16 Pcs
108 Pcs
16 Pcs
6060 mm
3060 mm

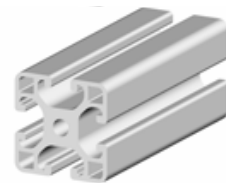

Item no. LS-I8 4040L SE

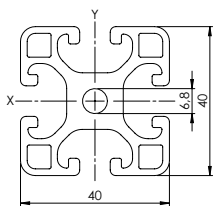

PU
LENGTH

16 Pcs.
6060 mm





Profile Grid 40

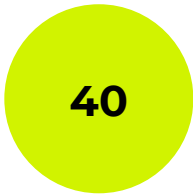

Item no. LS-I8 4040 / LS-I8 4040 PAL

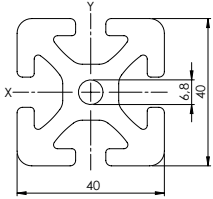

PU
PU / PAL
LENGTH

16 Pcs.
72 Pcs.
6060 mm

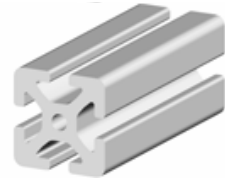

Item no. LS-I8 4040L3N

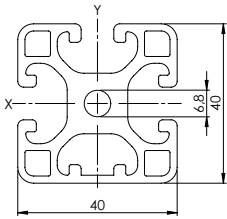

PU
LENGTH

16 Pcs.
6060 mm

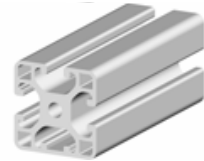

Item no. LS-I8 4040L2NE

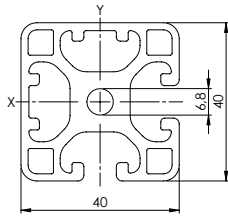

PU
LENGTH

16 Pcs.
6060 mm

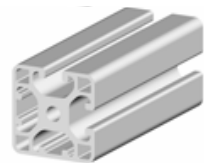

Item no. LS-I8 4040L2NP

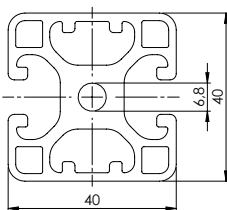

PU
LENGTH

16 Pcs.
6060 mm

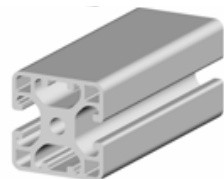



40

Profile Grid 40

Item no. LS-I8 4040LIN

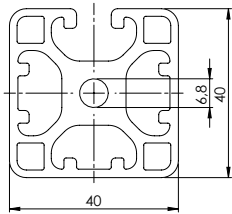

PU LENGTH 8 Pcs. 6060 mm

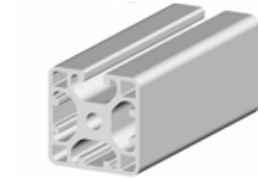

Item no. LS-I8 4080E / I8 4080E PAL

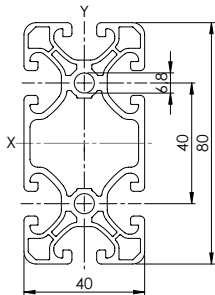

PU PU / PAL LENGTH 8 Pcs. 72 Pcs. 6060 mm

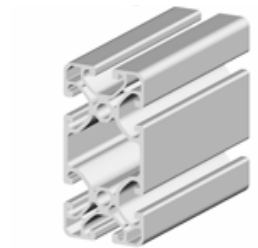

Item no. LS-I8 4080E3NE

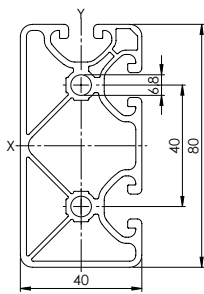

PU LENGTH 8 Pcs. 6060 mm

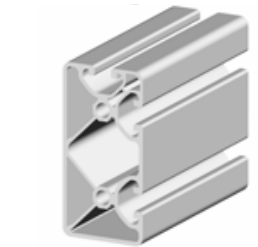

Item no. LS-I8 4080E2NP

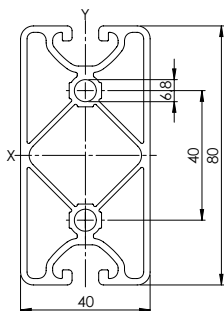

PU LENGTH 8 Pcs. 6060 mm

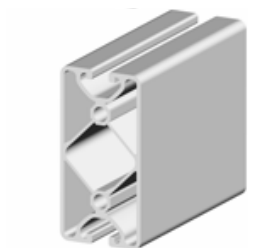

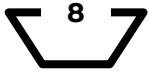

Profile Grid 40

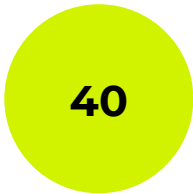

Item no. LS-I8 4080E4NP

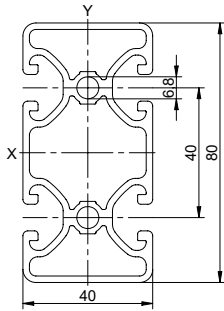

PU
LENGTH

8 Pcs.
6060 mm

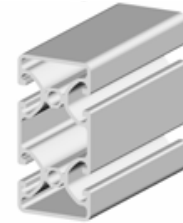

Item no. LS-I8 4080L / LS-I8 4080L PAL / LS-I8 4080L SL03

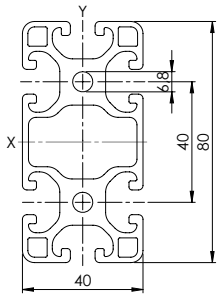

PU
PU / PAL
PU / SL03
LENGTH
LENGTH

8 Pcs.
63 Pcs.
8 Pcs.
6060 mm
3060 mm

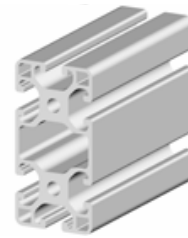

Item no. LS-I8 4080L SE

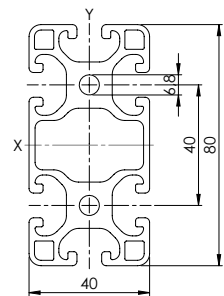

PU
LENGTH

8 Pcs.
6060 mm

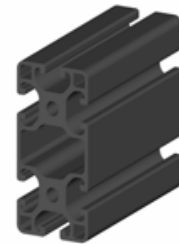

Item no. LS-I8 4080 / LS-I8 4080 PAL

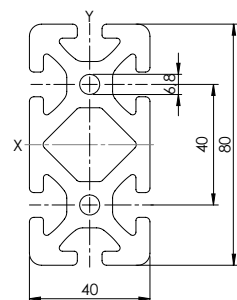

PU
PU / PAL
LENGTH

8 Pcs.
36 Pcs.
6060 mm

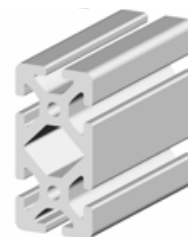



40 Profile Grid 40

Item no. LS-I8 4080L4N

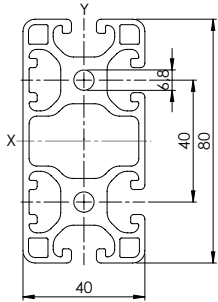

PU LENGTH

8 Pcs.
6060 mm

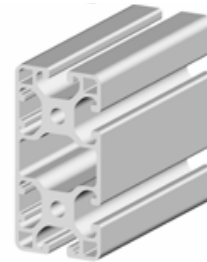

Item no. LS-I8 4080L5N

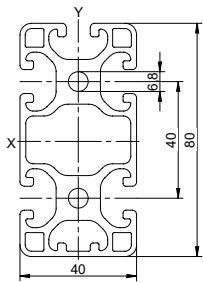

PU LENGTH

8 Pcs.
6060 mm

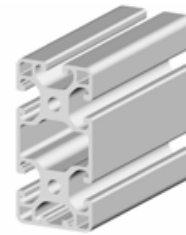

Item no. LS-I8 4080L3NE

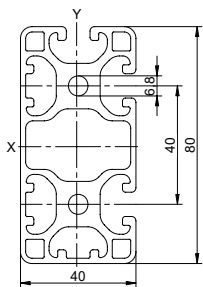

PU LENGTH

8 Pcs.
6060 mm

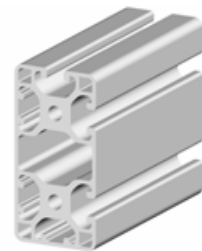

Item no. LS-I8 408080L

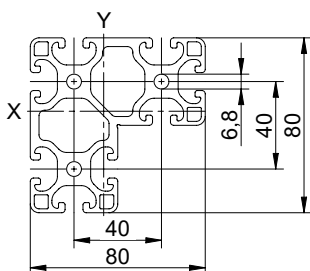

PU LENGTH

4 Pcs.
6060 mm

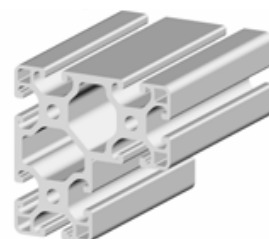



Profile Grid 40

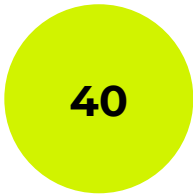

Item no. LS-I8 8080E

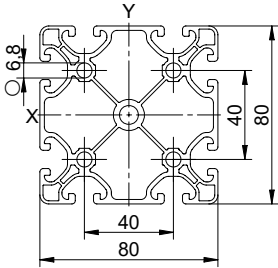

PU
LENGTH

4 Pcs.
6060 mm

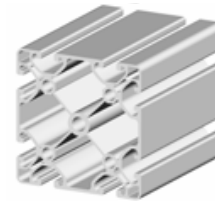

Item no. LS-I8 8080L / LS-I8 8080L PAL

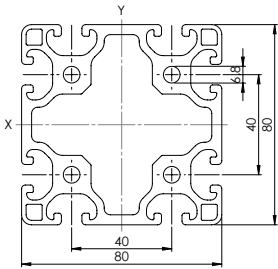

PU
PU / PAL
LENGTH

4 Pcs.
36 Pcs.
6060 mm

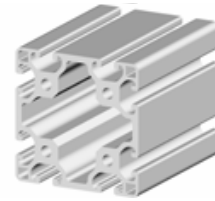

Item no. LS-I8 8080L SE

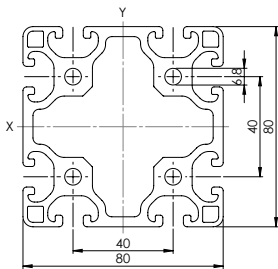

PU
LENGTH

4 Pcs.
6060 mm

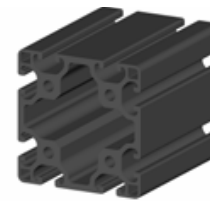

Item no. LS-I8 8080 / LS-I8 8080 PAL

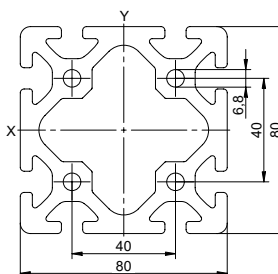

PU
PU / PAL
LENGTH

4 Pcs.
24 Pcs.
6060 mm

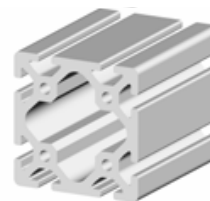



40

Profile Grid 40

Item no. LS-I8 8080L6N

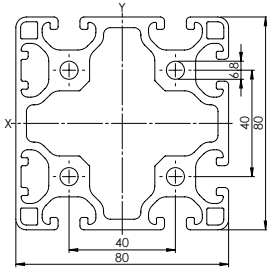

PU LENGTH

4 Pcs.
6060 mm

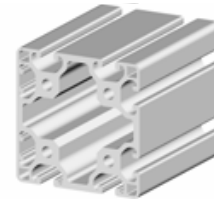

Item no. LS-I8 8080L4NE

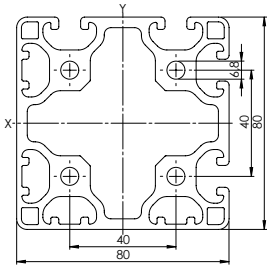

PU LENGTH

4 Pcs.
6060 mm

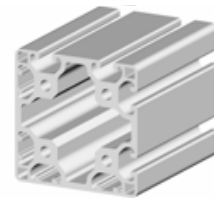

Item no. LS-I8 8080L45

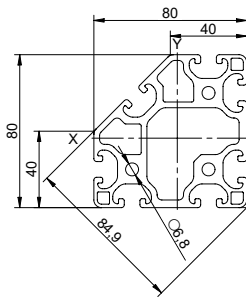

PU LENGTH

4 Pcs.
6060 mm

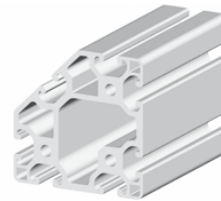

Item no. LS-I8 8080L4NE45

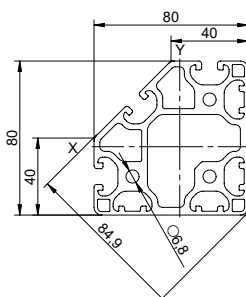

PU LENGTH

4 Pcs.
6060 mm

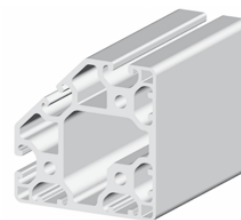



Profile Grid 40

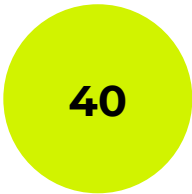

Item no. LS-18 80AP

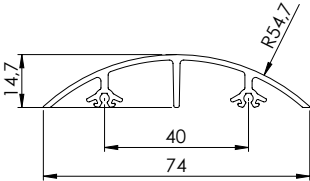

PU LENGTH

10 Pcs.
4150 mm



Item no. LS-18 40120L

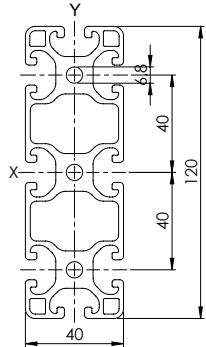

PU LENGTH

5 Pcs.
6060 mm

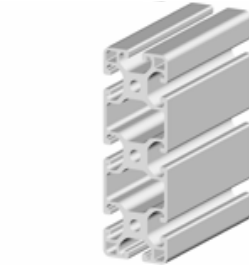

Item no. LS-18 40120L5N

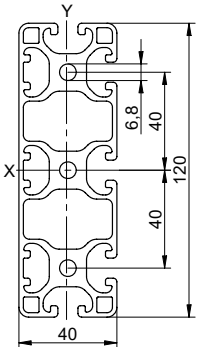

PU LENGTH

5 Pcs
6060 mm

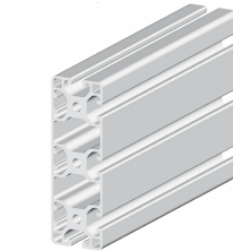

Item no. LS-18 40120

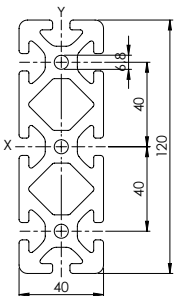

PU LENGTH

5 Pcs
6060 mm

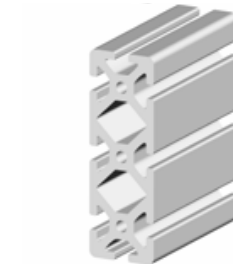



40

Profile Grid 40

Item no. LS-I8 40160L

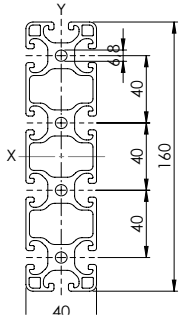

PU LENGTH

4 Pcs.
6060 mm



Item no. LS-I8 40160

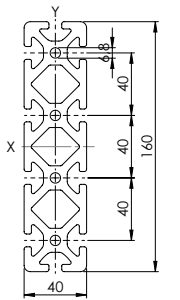

PU LENGTH

4 Pcs.
6060 mm



Item no. LS-I8 40160L6N

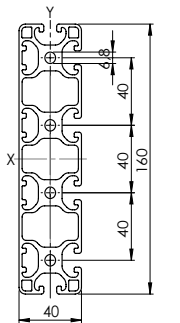

PU LENGTH

4 Pcs.
6060 mm



Item no. LS-I8 40200

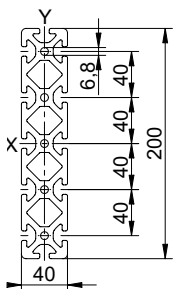

PU LENGTH

2 Pcs.
6060 mm





Profile Grid 40

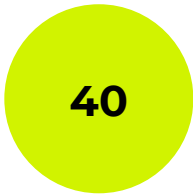

Item no. I8 80120L

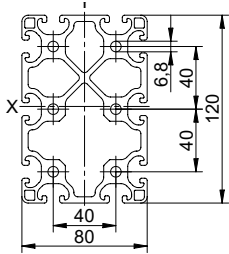

PU LENGTH

2 Pcs.
6060 mm

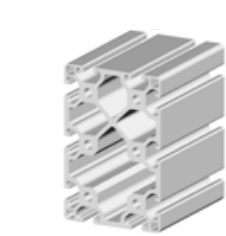

Item no. I8 80120

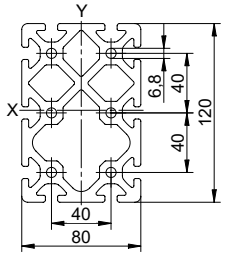

PU LENGTH

2 Pcs.
6060 mm

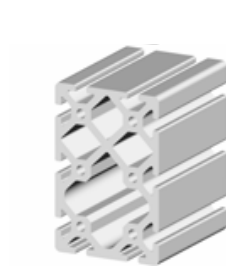

Item no. I8 120120

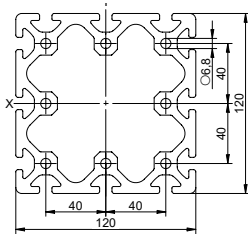

PU LENGTH

1 Pcs.
6060 mm

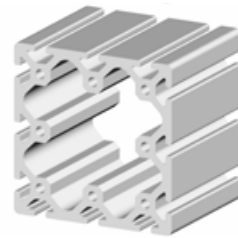

Item no. I8 80160L

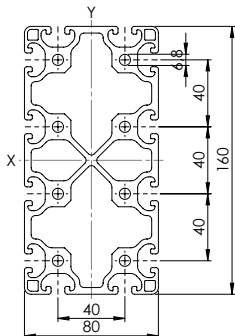

PU LENGTH

2 Pcs.
6060 mm

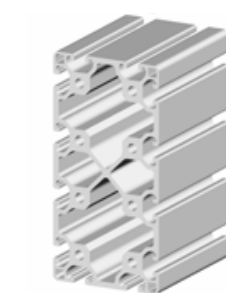



40 Profile Grid 40

Item no. LS-I8 80160

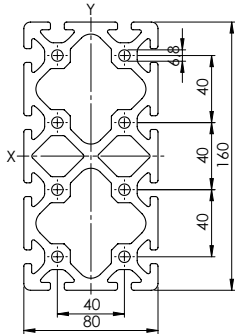

PU LENGTH

2 Pcs
6060 mm

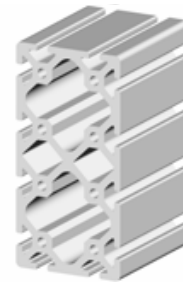

Item no. LS-I8 80160L8N

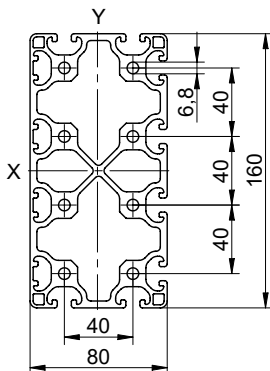

PU LENGTH

2 Pcs.
6060 mm

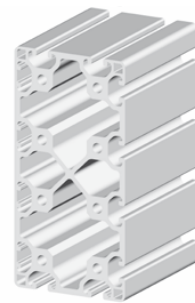

Item no. LS-I8 160160

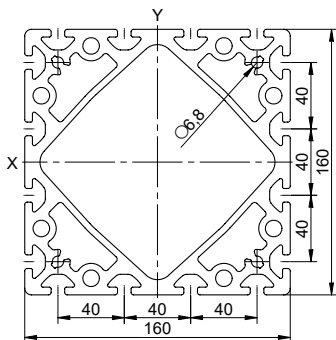

PU LENGTH

1 Pcs.
6060 mm

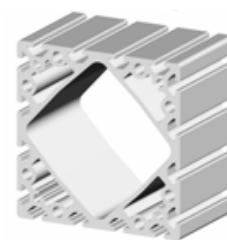

Item no. LS-I8 1640E / LS-I8 1640E SL06

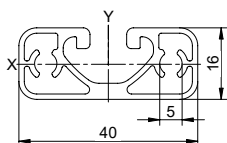

PU LENGTH
LENGTH

10 Pcs.
3060 mm
6060 mm

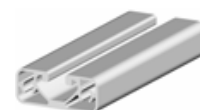



Profile Grid 40

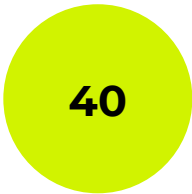

Item no. LS-I8 1640 / LS-I8 1640 SL06

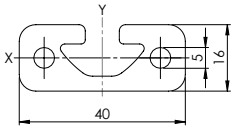

PU LENGTH 10 Pcs.
LENGTH 3060 mm
LENGTH 6060 mm

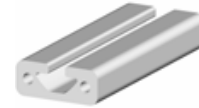

Item no. LS-I8 1680E

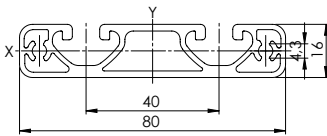

PU LENGTH 10 Pcs.
LENGTH 3060 mm



Item no. LS-I8 1680

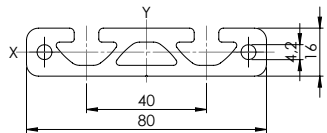

PU LENGTH 10 Pcs.
LENGTH 3060 mm



Item no. LS-I8 16160

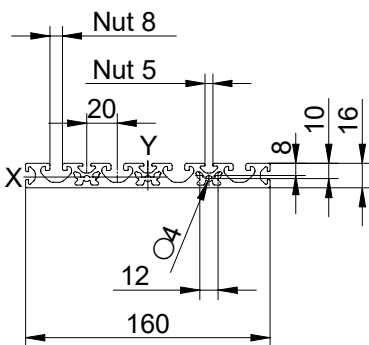

PU LENGTH 5 Pcs.
LENGTH 3060 mm

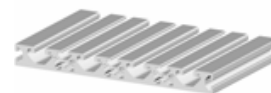



40

Profile Grid 40

Item no.	LS-I8 28160		
	PU LENGTH	5 Pcs. 6060 mm	
Item no.	LS-I8 28200		
	PU LENGTH	2 Pcs. 6060 mm	
Item no.	LS-I8 28240		
	PU LENGTH	2 Pcs. 6060 mm	
Item no.	LS-I8 4032L		
	PU LENGTH	10 Pcs. 6060 mm	

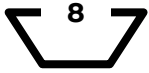

Profile Grid 40

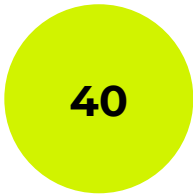

Item no. LS-I8 8032L

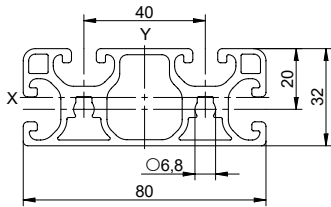

PU LENGTH

5 Pcs.
6060 mm

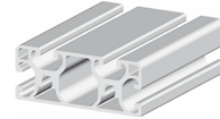

Item no. LS-I8 20152

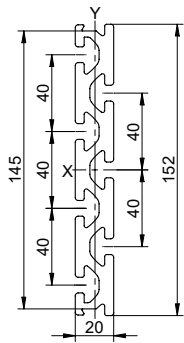

PU LENGTH

4 Pcs.
6060 mm



Item no. LS-I8 2055

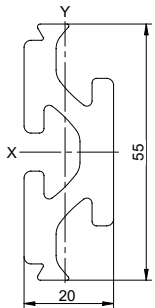

PU LENGTH

4 Pcs.
6060 mm



Item no. LS-I8 3218

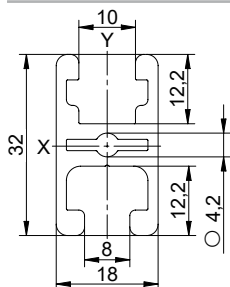

PU LENGTH

10 Pcs.
6060 mm

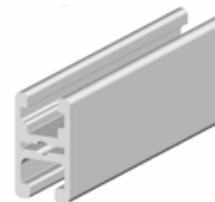



40

Profile Grid 40

Item no. LS-I8 4040E45°

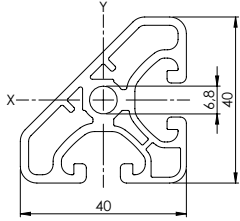

PU
LENGTH

8 Pcs.
6060 mm

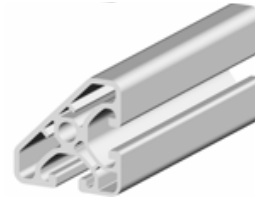

Item no. LS-I8 4040L45°

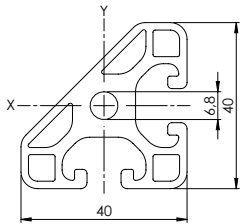

PU
LENGTH

8 Pcs.
6060 mm

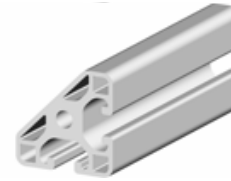

Item no. LS-I8 404045°

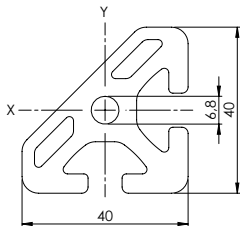

PU
LENGTH

8 Pcs.
6060 mm

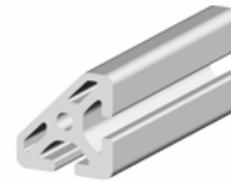

Item no. LS-I8 40RR30

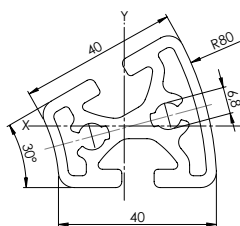

PU
LENGTH

6 Pcs.
6060 mm





Profile Grid 40

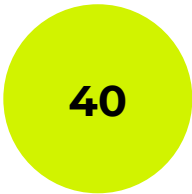

Item no. LS-I8 40RR45

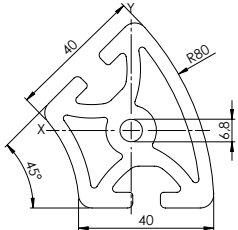

PU LENGTH

6 Pcs. 6060 mm



Item no. LS-I8 40RR60

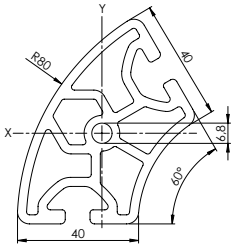

PU LENGTH

6 Pcs. 6060 mm



Item no. LS-I8 40LR90

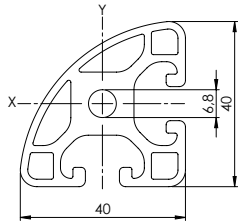

PU LENGTH

8 Pcs. 6060 mm

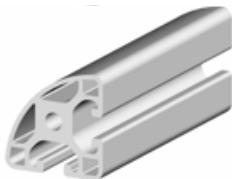

Item no. LS-I8 40RR90

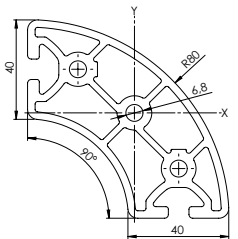

PU LENGTH

4 Pcs. 6060 mm



50

Profiles Grid 50



Item no. LS-I10 5050E

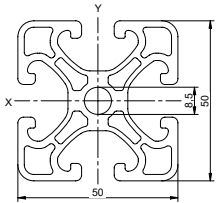

PU LENGTH

8 Pcs.
6060 mm

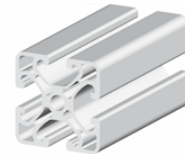

Item no. LS-I10 5050

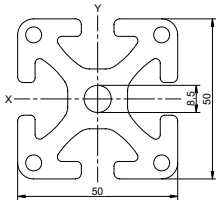

PU LENGTH

8 Pcs.
6060 mm

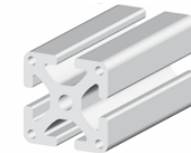

Item no. LS-I10 50100E

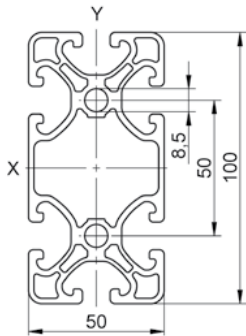

PU LENGTH

4 Pcs.
6060 mm

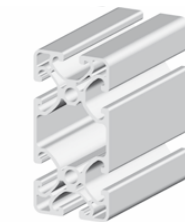

Item no. LS-I10 50100

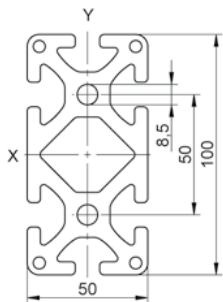

PU LENGTH

4 Pcs.
6060 mm

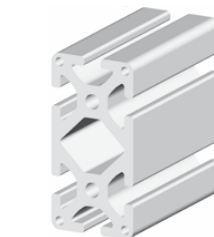

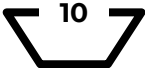

Profiles Grid 50

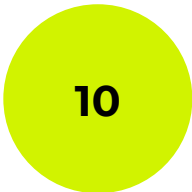

Item no. LS-I10 100100E

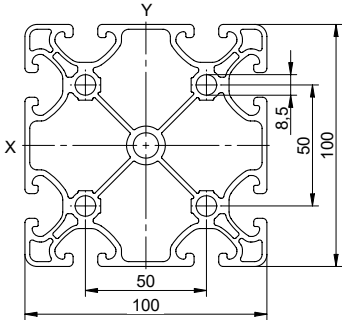

PU LENGTH

2 Pcs.
6060 mm

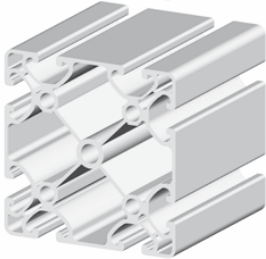

Item no. LS-I10 100100

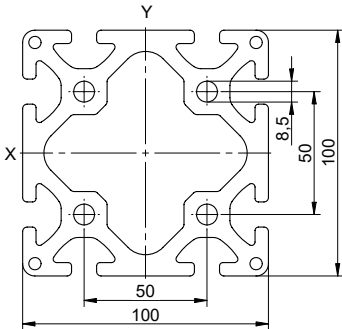

PU LENGTH

2 Pcs.
6060 mm

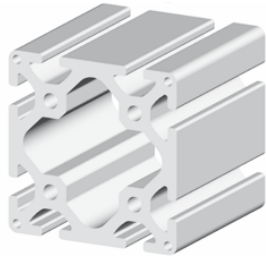

S

Special Profiles



Item no. LS-I6 3030EKP

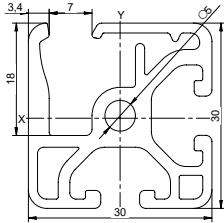

PU LENGTH

16 Pcs.
6060 mm

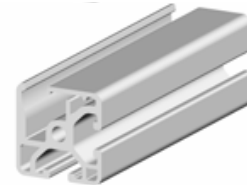

Item no. LS-I6 3030KP

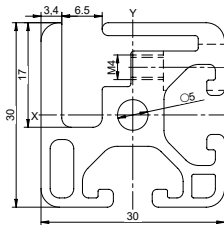

PU LENGTH

16 Pcs.
6060 mm



Item no. LS-I6 3030KP 180

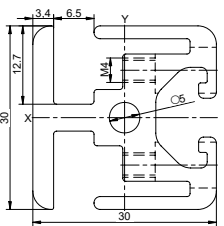

PU LENGTH

8 Pcs.
6060 mm



Item no. LS-I6 KP30

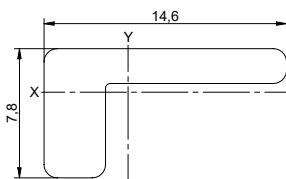

PU LENGTH

16 Pcs.
6060 mm

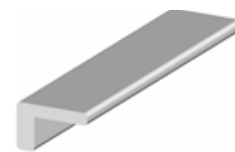



Special Profiles

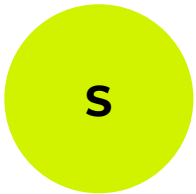

Item no. LS-I8 4040EKP

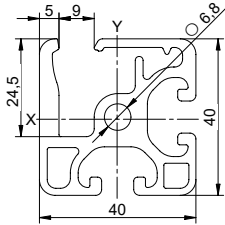

PU LENGTH

16Pcs.
6060 mm

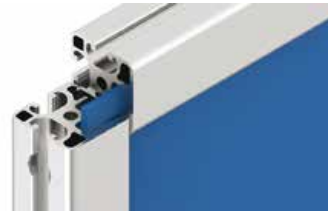
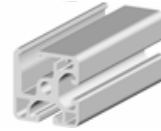

Item no. LS-I8 4040KP

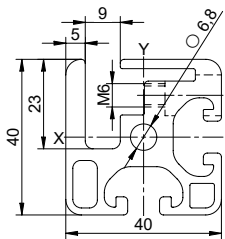

PU LENGTH

16 Pcs
6060 mm



Item no. LS-I8 4040KP 180

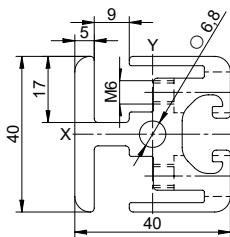

PU LENGTH

8 Pcs.
6060 mm



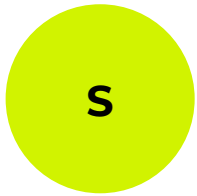

Special Profiles



Item no. LS-I8 KP40* **Edge profile for I8 4040KP und I8 4040KP 180*

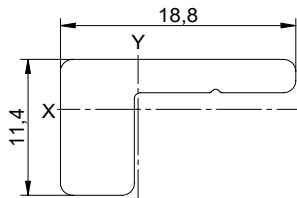

PU
LENGTH

16 Stk. / pcs.
6060 mm

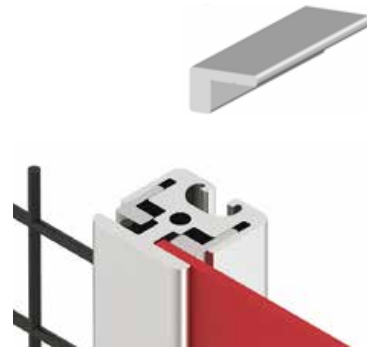

Item no. LS-I8 Frame profile 4020

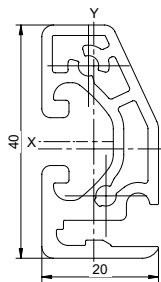

VPE / PU
LÄNGE / LENGTH

10 Stk. / pcs.
6060 mm





Special Profiles

S

Item no. LS-I8 SF1040

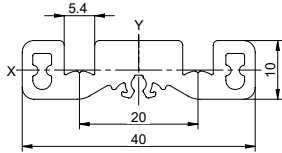
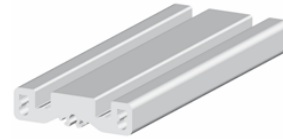
VPE / PU 10 Stk. / pcs.
LÄNGE / LENGTH 3060 mm

Item no. LS-I8 LRP D10

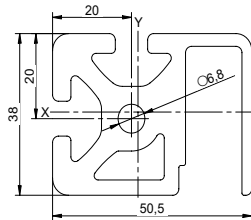
VPE / PU 4 Stk. / pcs.
LÄNGE / LENGTH 6060 mm

Item no. LS-I8 LRP D14

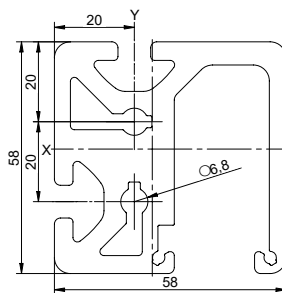
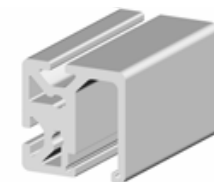
VPE / PU 4 Stk. / pcs.
LÄNGE / LENGTH 6060 mm

Item no. LS-I8 4040LBP

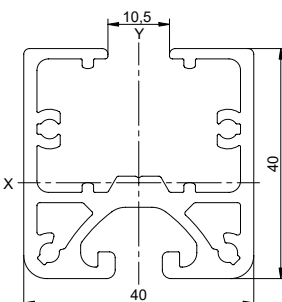
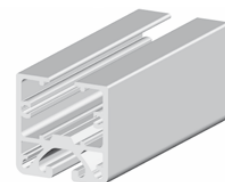
VPE / PU 8 Stk. / pcs.
LÄNGE / LENGTH 6060 mm

S

Special Profiles

Item no.	LS-W 40x25x2	
	PU LENGTH 20 Pcs. 3060 mm	
Item no.	LS-W 40x20x4	
	PU LENGTH 20 Pcs. 2060 mm	
Item no.	LS-W 40x40x4	
	PU LENGTH 20 Pcs. 2060 mm	
Item no.	LS-W 80x80x8	
	PU LENGTH 10 Pcs. 2060 mm	



Special Profiles

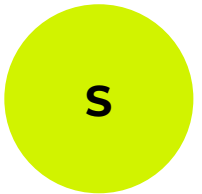

Item no. LS-P 40x4

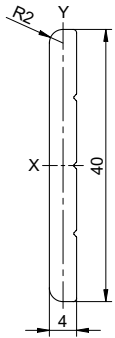

PU LENGTH

20 Pcs.
2060 mm

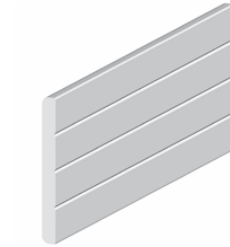

Item no. LS-I8 CSP Rail Profile

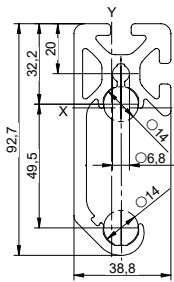

PU LENGTH

4 Pcs.
6060 mm



Item no. LS-I8 CSP Carriage Profile

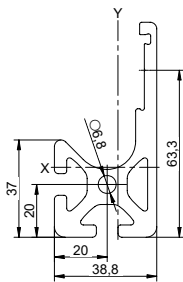

PU LENGTH

4 Pcs.
6060 mm



S

Special Profiles



Item no. LS-I8 4080T

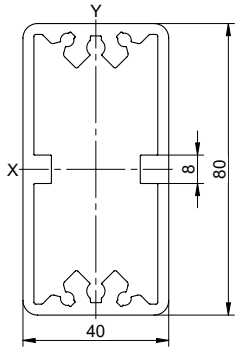

PU LENGTH

4 Pcs.
6060 mm



Item no. LS-I8 4080TI

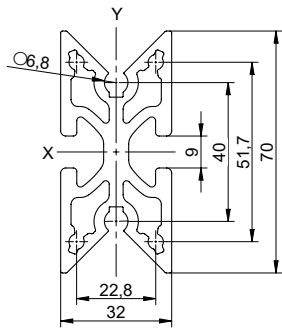

PU LENGTH

4 Pcs.
6060 mm



Item no. LS-I8 RB200

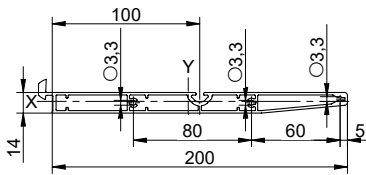

PU LENGTH

2 Pcs.
6060 mm

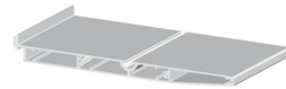

Item no. LS-I8 RB320

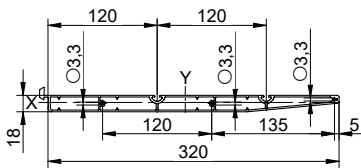

PU LENGTH

2 Pcs.
6060 mm

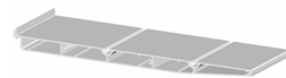



Tube Profiles

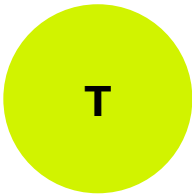

Item no. LS-I D30

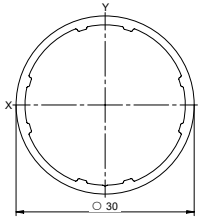

PU LENGTH

10 Pcs.
6060 mm

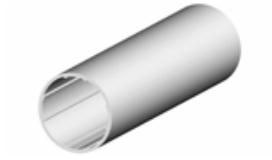

Item no. LS-I D30K

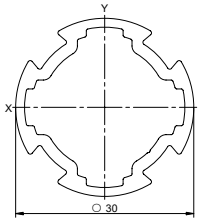

PU LENGTH

10 Pcs.
6060 mm



Item no. LS-I8 D30K1N

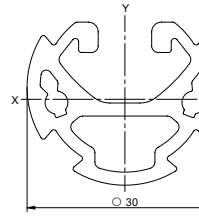

PU LENGTH

10 Pcs.
6060 mm



Item no. LS-I D30H

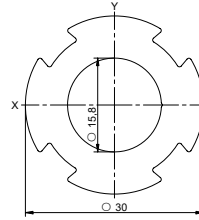

PU LENGTH

10 Pcs.
6060 mm



T

Tube Profiles



Item no. LS-I D32

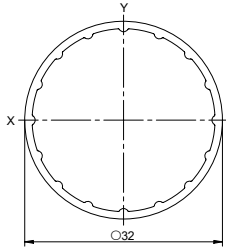

PU
LENGTH

10 Pcs.
3060 mm



Item no. LS-I D50

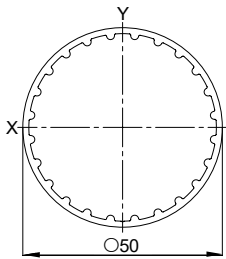

PU
LENGTH

9 Pcs.
6060 mm

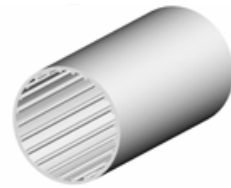



Conduit Profiles

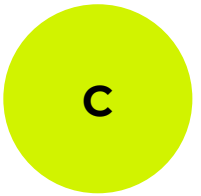

Item no. LS-I KK3030E

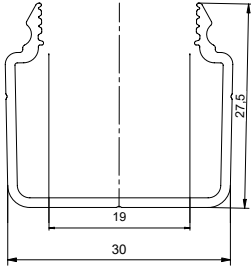

PU LENGTH

16 Pcs.
3060 mm

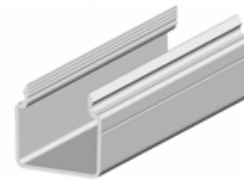

Item no. LS-I KK30D

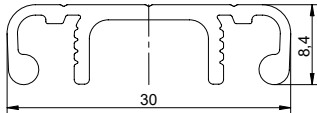

PU LENGTH

16 Pcs.
3060 mm



Item no. LS-I KK3060E

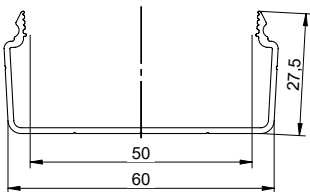

PU LENGTH

8 Pcs.
3060 mm

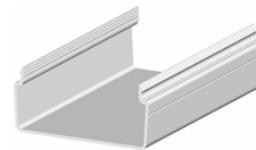

Item no. LS-I KK6060

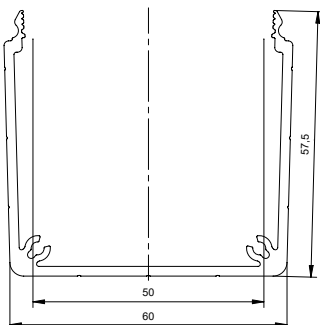

PU LENGTH

8 Pcs.
3060 mm

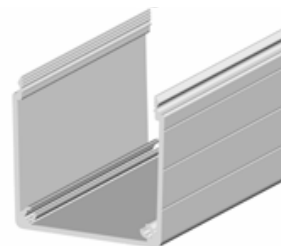

C

Conduit Profiles



Item no. LS-I KK6060E

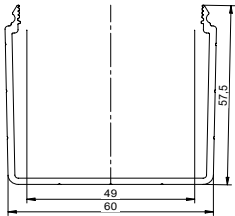

PU
LENGTH

16 Pcs.
3060 mm

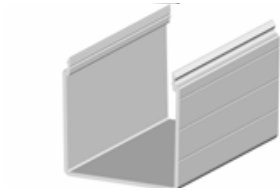

Item no. LS-I KK60D

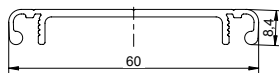

PU
LENGTH

8 Pcs.
3060 mm

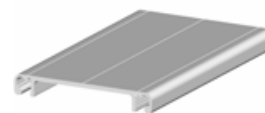

Item no. LS-I KK4020

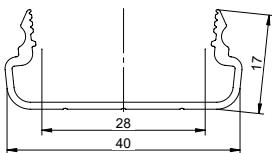

PU
LENGTH

12 Pcs.
3060 mm

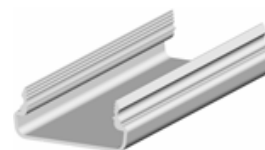

Item no. LS-I KK4040 / LS-I KK4040 SL06

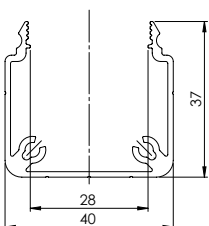

PU
LENGTH
LENGTH

12 Pcs.
3060 mm
6060 mm





Conduit Profiles

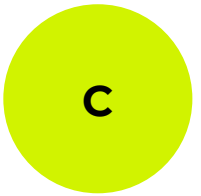

Item no. LS-I KK4040E

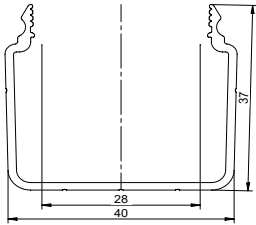

PU LENGTH 12 Pcs.
LENGTH 3060 mm

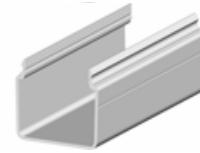

Item no. LS-I KK8040

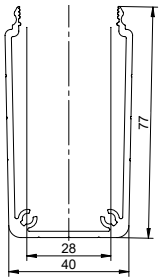

PU LENGTH 12 Pcs.
LENGTH 3060 mm



Item no. LS-I KK8040E

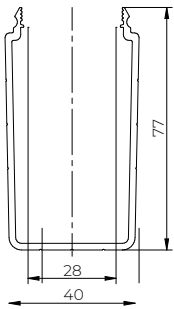

PU LENGTH 12 Pcs.
LENGTH 3060 mm



Item no. LS-I KK4080 / LS-I KK4080 SL06

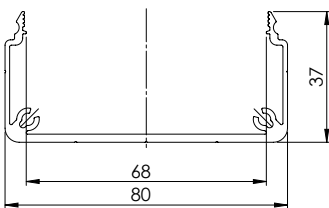

PU LENGTH 8 Pcs.
LENGTH 3060 mm
LENGTH 6060 mm

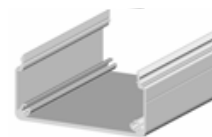

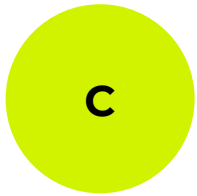

Conduit Profiles



Item no. LS-I KK4080E

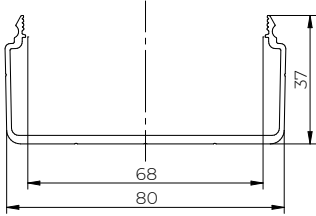

PU
LENGTH

8 Pcs.
3060 mm

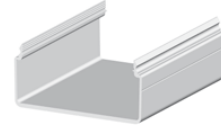

Item no. LS-I KK8080 / LS-I KK 8080 SL06

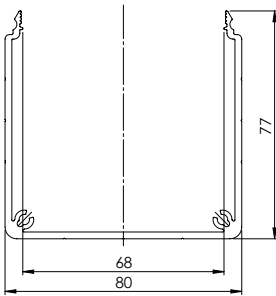

PU
LENGTH
LENGTH

8 Pcs.
3060 mm
6060 mm

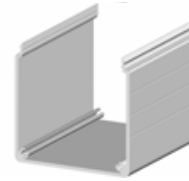

Item no. LS-I KK8080E

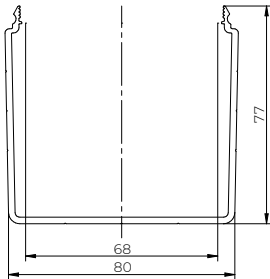

PU
LENGTH

8 Pcs.
3060 mm



Item no. LS-I KK40D / LS-I KK40D SL06

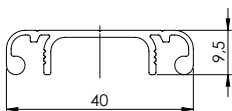

PU
LENGTH
LENGTH

12 Pcs.
3060 mm
6060 mm

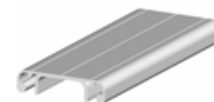



Conduit Profiles

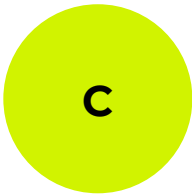

Item no. LS-I KK80D / LS-I KK80D SL06

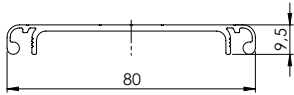

PU LENGTH 80
LENGTH 3060 mm
LENGTH 6060 mm

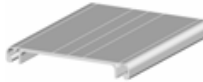

Item no. LS-I TP 80

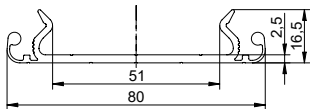

PU LENGTH 80
LENGTH 3060 mm

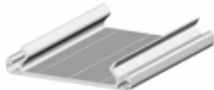

Item no. LS-I8 TP 80

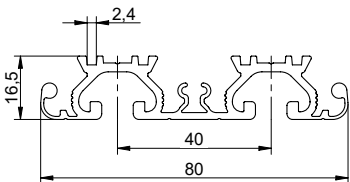

PU LENGTH 80
LENGTH 3060 mm



C

Conduit Profiles



Item no. LS-I WP 40

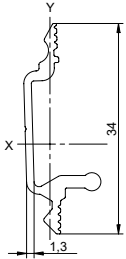

PU LENGTH

10 Pcs.
6060 mm



Item no. LS-I WP 80

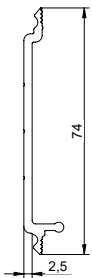

PU LENGTH

10 Pcs.
3060 mm



Item no. LS-I TP 120

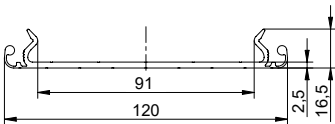

PU LENGTH

10 Pcs.
3060 mm

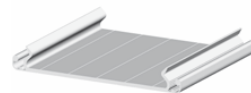

Item no. LS-I8 TP 120

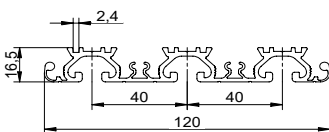

PU LENGTH

10 Pcs.
3060 mm

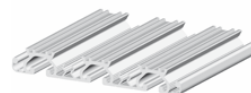



Conduit Profiles

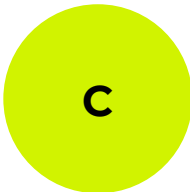

Item no. LS-I WP 120



PU LENGTH

10 Pcs.
3060 mm



Item no. LS-I TP 160

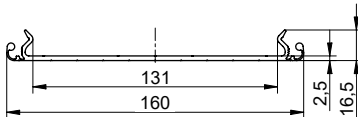

PU LENGTH

10 Pcs.
3060 mm

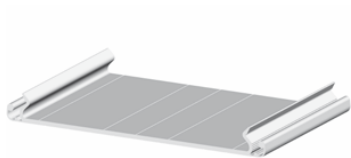

M

Miscellaneous Profiles



Item no. LS-I8 4080 SP2K

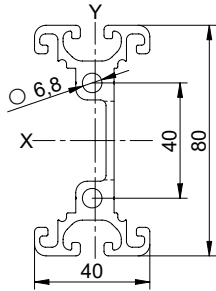

PU
LENGTH

8 Pcs.
6060 mm

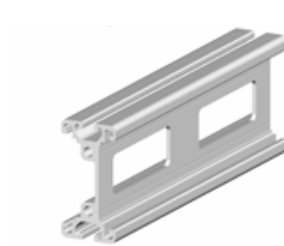

Item no. LS-I8 Cover Profile AL60

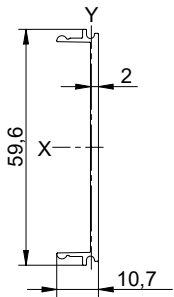

PU
LENGTH

10 Pcs.
3060 mm



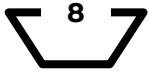

Miscellaneous Profiles

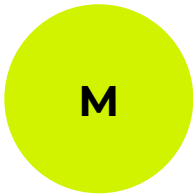

Item no. LS-I8 Connection Profile 40

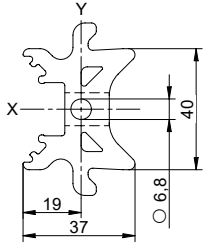

PU LENGTH

6 Pcs.
6060 mm



Item no. LS-I8 Cover Profile 32 AL

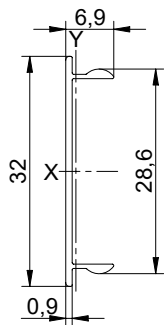

PU LENGTH

10 Pcs.
3060 mm



M

Miscellaneous Profiles

Item no. LS-I5 Shaft Profile 6

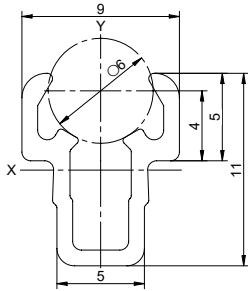

PU LENGTH 20 Pcs. 3060 mm



Item no. LS-I8 Shaft Profile 10

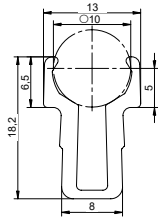

PU LENGTH 10 Pcs. 3060 mm

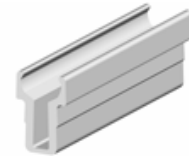

Item no. LS-I8 Shaft Profile 14

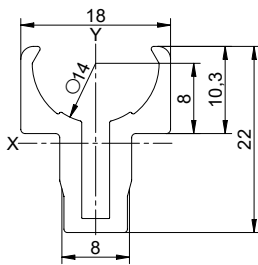

PU LENGTH 10 Pcs. 3060 mm

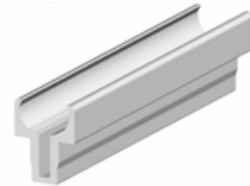

Item no. LS-I5 Handle Profile

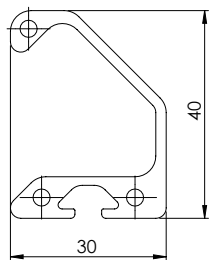

PU LENGTH 10 Pcs. 3060 mm





Miscellaneous Profiles

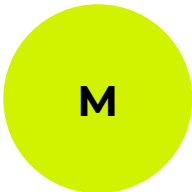

Item no. LS-I8 Hinge Profile e

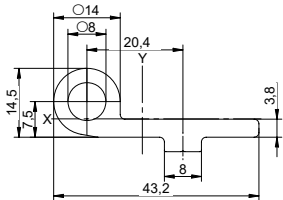

PU LENGTH 10 Pcs. 3060 mm

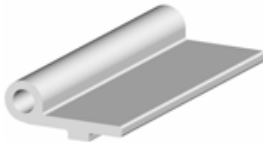

Item no. LS-I8 Hinge Profile z

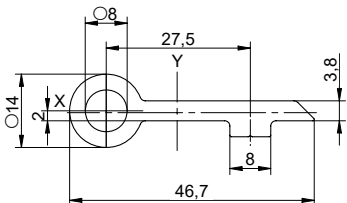

PU LENGTH 10 Pcs. 3060 mm



Item no. LS-I8 Panel Clamping Profile

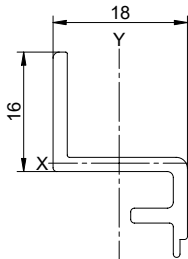

PU LENGTH 12 Pcs. 3060 mm



M

Miscellaneous Profiles



Item no.

LS-I8 WSL E

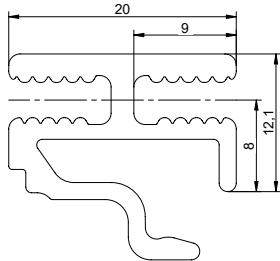

PU
LENGTH

16 Pcs.
3060 mm

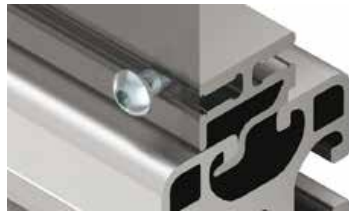
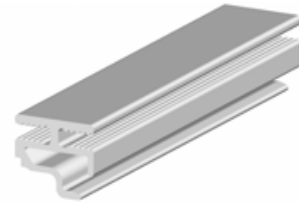

Item no.

LS-I8 WL

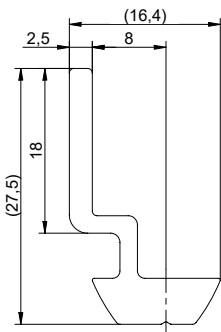

PU
LENGTH

16 Pcs.
2060 mm

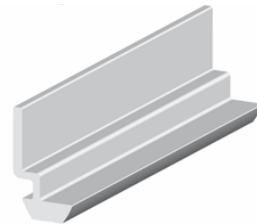



Miscellaneous Profiles

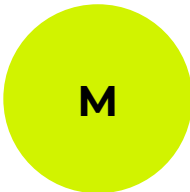

Item no. LS-I8 RP01

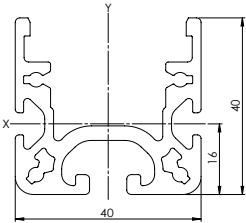

PU LENGTH 20 Pcs. 6060 mm

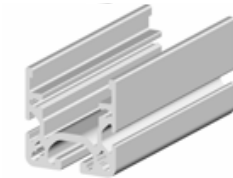

Item no. LS-I6 Cover Profile Al

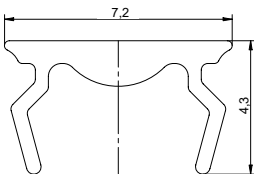

PU LENGTH 25 Pcs. 2000 mm

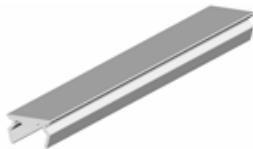

Item no. LS-I8 WL M6

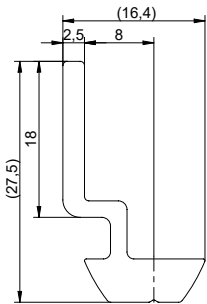

PU LENGTH 10 Pcs. 2000 mm

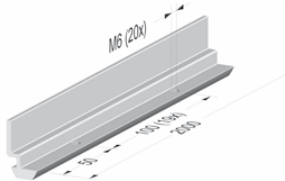

Item no. LS-I8 WL M6 KM

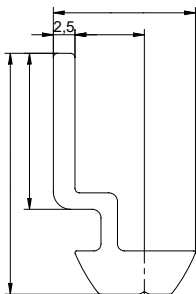

PU LENGTH 10 Pcs. 2048 mm

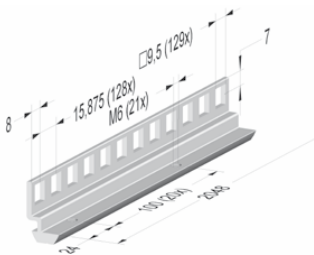

M

Miscellaneous Profiles



Item no. LS-I8 WL K M5

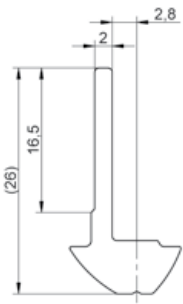

PU
LENGTH

10 Pcs.
2000 mm

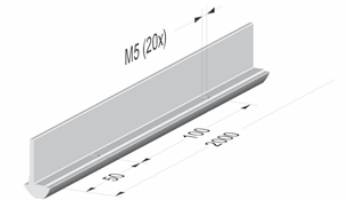

Item no. LS-I8 NP M8 40

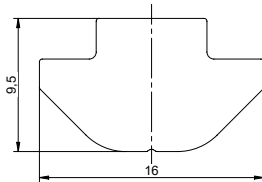

PU
LENGTH

10 Pcs.
2000 mm

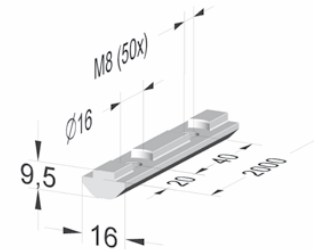

Item no. LS-I8 NP M8 60

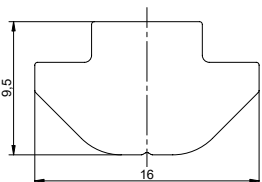

PU
LENGTH

10 Pcs.
2000 mm

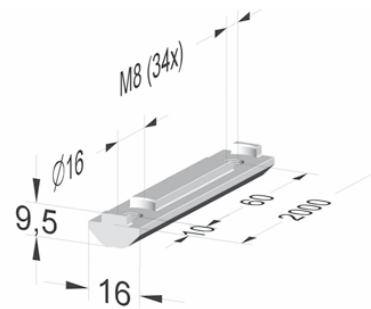

Item no. LS-I8 NP

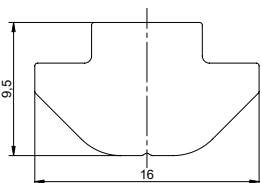

PU
LENGTH

16 Pcs.
3060 mm

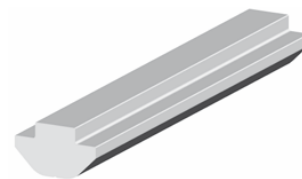



Profiles X Grid 40



Item no. LS-I8 X4040TP

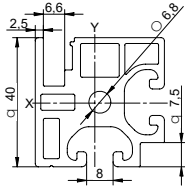

PU
LENGTH

8 Pcs.
6060 mm

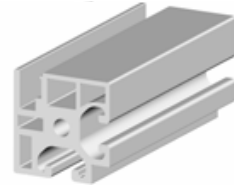

Item no. LS-I8 X4080L4N

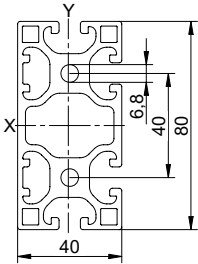

PU
LENGTH

8 Pcs.
6060 mm

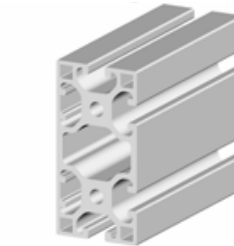

Item no. LS-I8 X4080L4N K

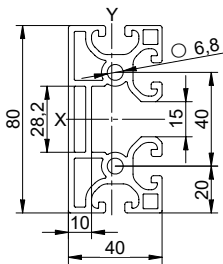

PU
LENGTH

8 Pcs.
6060 mm

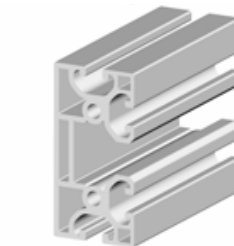

Item no. LS-I8 X4080L5N

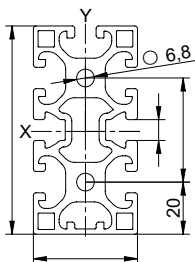

PU
LENGTH

8 Pcs.
6060 mm

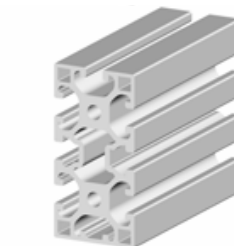



X40 Profiles X Grid 40



Item no. LS-I8 X40120L

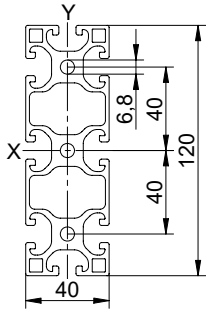

PU LENGTH

4 Pcs.
6060 mm



Item no. LS-I8 X8080L4NE

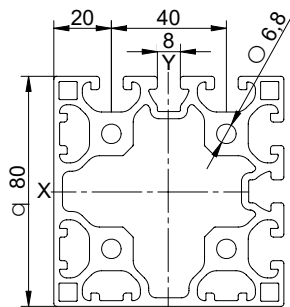

PU LENGTH

4 Pcs.
6060 mm

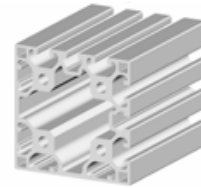

Item no. LS-I8 X8080L2NPK

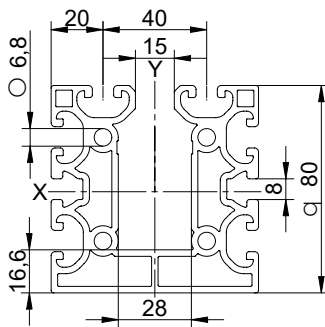

PU LENGTH

4 Pcs.
6060 mm

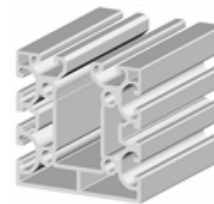

- We deliver **components & solutions.**

L-SYSTEM AB (*Head office*)

Mörsaregatan 20
254 66 Helsingborg
SWEDEN
info@l-system.se
+46 (0)42 38 61 50

L-SYSTEM ApS

Roms Hule 8 (Østtårne)
7100 Vejle
DENMARK
info@l-system.dk
+45 32 26 80 81

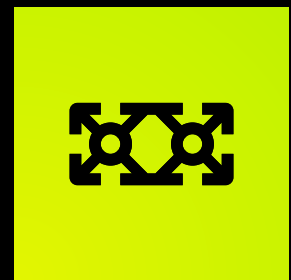
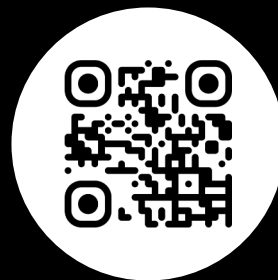

L-SYSTEM